

- 1
- 2
- 3
- 4
- 5
- 6
- 7
- 8
- 9
- 10
- 11
- 12
- 13
- 14
- 15
- 16
- 17
- 18

LEVER BODY

Die-cast zinc alloy with epoxy resin coating, RAL 9005 black colour, matte finish.

STANDARD EXECUTIONS

Black-oxide steel clamping element and retaining screw. Steel return spring.

Retaining screw with six-lobed socket to fit TORX®.

- **GN 306-MS**: brass pad.
- **GN 306-KU**: acetal resin based (POM) technopolymer pad, natural colour.
- **GN 306-DZ**: pad with hardened oval end.
- **GN 306-ZK**: pad with spherical end.
- **GN 306-KD**: pad with spherical end and thrust pad (supplied not assembled) made out of acetal based (POM) technopolymer, black colour, matte finish.

FEATURES AND APPLICATIONS

Particularly suitable when the lever turning angle is limited owing to lack of space.

Pad made out of brass (GN 306-MS) or of acetal based technopolymer (GN 306-KU) to avoid damage to the contact surface.

Pad with oval end (GN 306-DZ) for applications requiring a point of contact.

Spherical end and thrust pad made out of technopolymer (GN 306-KD) useful with irregular or non-parallel surfaces to perform clamping without transmitting the rotation onto the clamping surface.

SPECIAL EXECUTIONS ON REQUEST

- Lever body in different colours.
- Stainless steel clamping element.
- Straight lever body like GN 302 (page. 391).

INSTRUCTIONS OF USE

For clamping, lift the lever to disengage the clamping device teeth and bring it back to start position. By releasing the lever, the return spring automatically engages the teeth.

If the lever cannot make a 360° rotation, the clamping element can be easily screwed by means of the six-lobed socket front head screw (after having disengaged the lever).

* Registered trademark by TEXTRON INC.



Conversion Table	
1 mm = 0.039 inch	
↓	
l1	
mm	inch
30	1.18
45	1.77
63	2.48

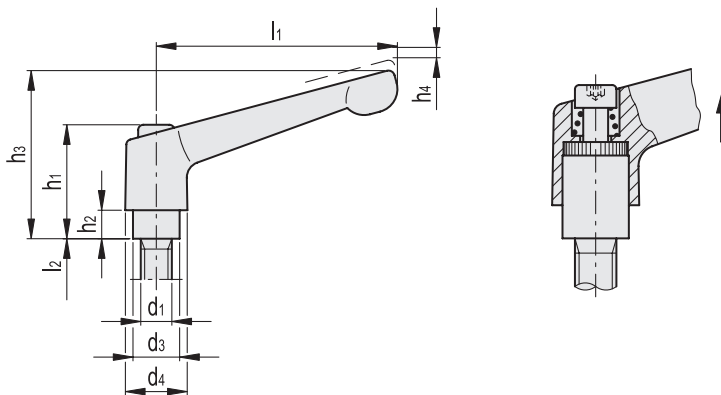

GN 306-MS
GN 306-KU

GN 306-DZ

GN 306-ZK

GN 306-KD

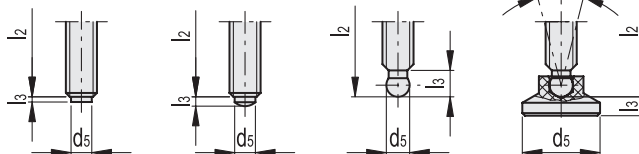

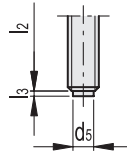
GN 306-MS
GN 306-KU

METRIC

GN 306-MS

Code	Description	l1	d1	d3	d4	d5	h1	h2	h3	h4	l2	l3	⚖️
GN.51207	GN 306-30-M6-16-MS-SW	30	M6	10	13	4	24.5	4	31	3.5	16	1	27
GN.51217	GN 306-30-M6-20-MS-SW	30	M6	10	13	4	24.5	4	31	3.5	20	1	29
GN.51227	GN 306-30-M6-25-MS-SW	30	M6	10	13	4	24.5	4	31	3.5	25	1	30
GN.51237	GN 306-30-M6-32-MS-SW	30	M6	10	13	4	24.5	4	31	3.5	32	1	31
GN.51247	GN 306-30-M6-40-MS-SW	30	M6	10	13	4	24.5	4	31	3.5	40	1	33
GN.51257	GN 306-30-M6-50-MS-SW	30	M6	10	13	4	24.5	4	31	3.5	50	1	34
GN.51407	GN 306-45-M6-16-MS-SW	45	M6	10	13	4	24.5	4	35	3.5	16	1	40
GN.51417	GN 306-45-M6-20-MS-SW	45	M6	10	13	4	24.5	4	35	3.5	20	1	50
GN.51427	GN 306-45-M6-25-MS-SW	45	M6	10	13	4	24.5	4	35	3.5	25	1	58
GN.51437	GN 306-45-M6-32-MS-SW	45	M6	10	13	4	24.5	4	35	3.5	32	1	59
GN.51447	GN 306-45-M6-40-MS-SW	45	M6	10	13	4	24.5	4	35	3.5	40	1	60
GN.51457	GN 306-45-M6-50-MS-SW	45	M6	10	13	4	24.5	4	35	3.5	50	1	62
GN.51607	GN 306-63-M8-20-MS-SW	63	M8	13.5	17.5	6	31	6.5	45	4	20	1.5	80
GN.51617	GN 306-63-M8-25-MS-SW	63	M8	13.5	17.5	6	31	6.5	45	4	25	1.5	87
GN.51627	GN 306-63-M8-32-MS-SW	63	M8	13.5	17.5	6	31	6.5	45	4	32	1.5	90
GN.51637	GN 306-63-M8-40-MS-SW	63	M8	13.5	17.5	6	31	6.5	45	4	40	1.5	91
GN.51647	GN 306-63-M8-50-MS-SW	63	M8	13.5	17.5	6	31	6.5	45	4	50	1.5	95
GN.51657	GN 306-63-M8-63-MS-SW	63	M8	13.5	17.5	6	31	6.5	45	4	63	1.5	100
GN.51667	GN 306-63-M10-20-MS-SW	63	M10	13.5	17.5	8	31	6.5	45	4	20	2	80
GN.51677	GN 306-63-M10-25-MS-SW	63	M10	13.5	17.5	8	31	6.5	45	4	25	2	85
GN.51687	GN 306-63-M10-32-MS-SW	63	M10	13.5	17.5	8	31	6.5	45	4	32	2	90
GN.51697	GN 306-63-M10-40-MS-SW	63	M10	13.5	17.5	8	31	6.5	45	4	40	2	95
GN.51707	GN 306-63-M10-50-MS-SW	63	M10	13.5	17.5	8	31	6.5	45	4	50	2	98
GN.51717	GN 306-63-M10-63-MS-SW	63	M10	13.5	17.5	8	31	6.5	45	4	63	2	104

GN 306-KU

Code	Description	l1	d1	d3	d4	d5	h1	h2	h3	h4	l2	l3	⚖️
GN.51205	GN 306-30-M6-16-KU-SW	30	M6	10	13	3.5	24.5	4	31	3.5	16	1.3	27
GN.51215	GN 306-30-M6-20-KU-SW	30	M6	10	13	3.5	24.5	4	31	3.5	20	1.3	29
GN.51225	GN 306-30-M6-25-KU-SW	30	M6	10	13	3.5	24.5	4	31	3.5	25	1.3	30
GN.51235	GN 306-30-M6-32-KU-SW	30	M6	10	13	3.5	24.5	4	31	3.5	32	1.3	31
GN.51245	GN 306-30-M6-40-KU-SW	30	M6	10	13	3.5	24.5	4	31	3.5	40	1.3	32
GN.51255	GN 306-30-M6-50-KU-SW	30	M6	10	13	3.5	24.5	4	31	3.5	50	1.3	34
GN.51405	GN 306-45-M6-16-KU-SW	45	M6	10	13	3.5	24.5	4	35	3.5	16	1.3	40
GN.51415	GN 306-45-M6-20-KU-SW	45	M6	10	13	3.5	24.5	4	35	3.5	20	1.3	50
GN.51425	GN 306-45-M6-25-KU-SW	45	M6	10	13	3.5	24.5	4	35	3.5	25	1.3	58
GN.51435	GN 306-45-M6-32-KU-SW	45	M6	10	13	3.5	24.5	4	35	3.5	32	1.3	59
GN.51445	GN 306-45-M6-40-KU-SW	45	M6	10	13	3.5	24.5	4	35	3.5	40	1.3	60
GN.51455	GN 306-45-M6-50-KU-SW	45	M6	10	13	3.5	24.5	4	35	3.5	50	1.3	62
GN.51605	GN 306-63-M8-20-KU-SW	63	M8	13.5	17.5	5	31	6.5	45	4	20	1.6	78
GN.51615	GN 306-63-M8-25-KU-SW	63	M8	13.5	17.5	5	31	6.5	45	4	25	1.6	80
GN.51625	GN 306-63-M8-32-KU-SW	63	M8	13.5	17.5	5	31	6.5	45	4	32	1.6	87
GN.51635	GN 306-63-M8-40-KU-SW	63	M8	13.5	17.5	5	31	6.5	45	4	40	1.6	88
GN.51645	GN 306-63-M8-50-KU-SW	63	M8	13.5	17.5	5	31	6.5	45	4	50	1.6	89
GN.51655	GN 306-63-M8-63-KU-SW	63	M8	13.5	17.5	5	31	6.5	45	4	63	1.6	91
GN.51665	GN 306-63-M10-20-KU-SW	63	M10	13.5	17.5	6.5	31	6.5	45	4	20	1.9	80
GN.51675	GN 306-63-M10-25-KU-SW	63	M10	13.5	17.5	6.5	31	6.5	45	4	25	1.9	84
GN.51685	GN 306-63-M10-32-KU-SW	63	M10	13.5	17.5	6.5	31	6.5	45	4	32	1.9	86
GN.51695	GN 306-63-M10-40-KU-SW	63	M10	13.5	17.5	6.5	31	6.5	45	4	40	1.9	90
GN.51705	GN 306-63-M10-50-KU-SW	63	M10	13.5	17.5	6.5	31	6.5	45	4	50	1.9	96
GN.51715	GN 306-63-M10-63-KU-SW	63	M10	13.5	17.5	6.5	31	6.5	45	4	63	1.9	103



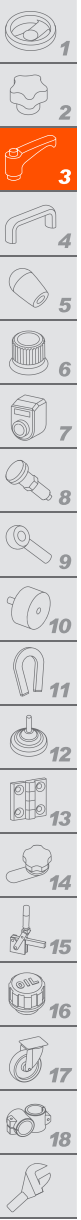

Clamping levers

GN 306-DZ

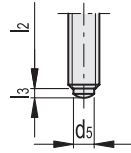

GN 306-ZK

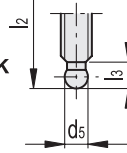

METRIC

GN 306-DZ

Code	Description	l1	d1	d3	d4	d5	h1	h2	h3	h4	l2	l3	
GN.51201	GN 306-30-M6-16-DZ-SW	30	M6	10	13	4	24.5	4	31	3.5	16	1.8	28
GN.51211	GN 306-30-M6-20-DZ-SW	30	M6	10	13	4	24.5	4	31	3.5	20	1.8	29
GN.51221	GN 306-30-M6-25-DZ-SW	30	M6	10	13	4	24.5	4	31	3.5	25	1.8	30
GN.51231	GN 306-30-M6-32-DZ-SW	30	M6	10	13	4	24.5	4	31	3.5	32	1.8	31
GN.51241	GN 306-30-M6-40-DZ-SW	30	M6	10	13	4	24.5	4	31	3.5	40	1.8	33
GN.51251	GN 306-30-M6-50-DZ-SW	30	M6	10	13	4	24.5	4	31	3.5	50	1.8	34
GN.51401	GN 306-45-M6-16-DZ-SW	45	M6	10	13	4	24.5	4	35	3.5	16	1.8	56
GN.51411	GN 306-45-M6-20-DZ-SW	45	M6	10	13	4	24.5	4	35	3.5	20	1.8	57
GN.51421	GN 306-45-M6-25-DZ-SW	45	M6	10	13	4	24.5	4	35	3.5	25	1.8	58
GN.51431	GN 306-45-M6-32-DZ-SW	45	M6	10	13	4	24.5	4	35	3.5	32	1.8	59
GN.51441	GN 306-45-M6-40-DZ-SW	45	M6	10	13	4	24.5	4	35	3.5	40	1.8	61
GN.51451	GN 306-45-M6-50-DZ-SW	45	M6	10	13	4	24.5	4	35	3.5	50	1.8	62
GN.51601	GN 306-63-M8-20-DZ-SW	63	M8	13.5	17.5	6	31	6.5	45	4	20	2.5	50
GN.51611	GN 306-63-M8-25-DZ-SW	63	M8	13.5	17.5	6	31	6.5	45	4	25	2.5	64
GN.51621	GN 306-63-M8-32-DZ-SW	63	M8	13.5	17.5	6	31	6.5	45	4	32	2.5	83
GN.51631	GN 306-63-M8-40-DZ-SW	63	M8	13.5	17.5	6	31	6.5	45	4	40	2.5	85
GN.51641	GN 306-63-M8-50-DZ-SW	63	M8	13.5	17.5	6	31	6.5	45	4	50	2.5	89
GN.51651	GN 306-63-M8-63-DZ-SW	63	M8	13.5	17.5	6	31	6.5	45	4	63	2.5	92
GN.51661	GN 306-63-M10-20-DZ-SW	63	M10	13.5	17.5	8	31	6.5	45	4	20	3.5	86
GN.51671	GN 306-63-M10-25-DZ-SW	63	M10	13.5	17.5	8	31	6.5	45	4	25	3.5	93
GN.51681	GN 306-63-M10-32-DZ-SW	63	M10	13.5	17.5	8	31	6.5	45	4	32	3.5	95
GN.51691	GN 306-63-M10-40-DZ-SW	63	M10	13.5	17.5	8	31	6.5	45	4	40	3.5	98
GN.51701	GN 306-63-M10-50-DZ-SW	63	M10	13.5	17.5	8	31	6.5	45	4	50	3.5	100
GN.51711	GN 306-63-M10-63-DZ-SW	63	M10	13.5	17.5	8	31	6.5	45	4	63	3.5	104

GN 306-ZK

Code	Description	l1	d1	d3	d4	d5	h1	h2	h3	h4	l2	l3	
GN.51209	GN 306-30-M6-16-ZK-SW	30	M6	10	13	4.5±0.03	24.5	4	31	3.5	16	5.1	24
GN.51219	GN 306-30-M6-20-ZK-SW	30	M6	10	13	4.5±0.03	24.5	4	31	3.5	20	5.1	29
GN.51229	GN 306-30-M6-25-ZK-SW	30	M6	10	13	4.5±0.03	24.5	4	31	3.5	25	5.1	30
GN.51239	GN 306-30-M6-32-ZK-SW	30	M6	10	13	4.5±0.03	24.5	4	31	3.5	32	5.1	31
GN.51249	GN 306-30-M6-40-ZK-SW	30	M6	10	13	4.5±0.03	24.5	4	31	3.5	40	5.1	32
GN.51259	GN 306-30-M6-50-ZK-SW	30	M6	10	13	4.5±0.03	24.5	4	31	3.5	50	5.1	34
GN.51409	GN 306-45-M6-16-ZK-SW	45	M6	10	13	4.5±0.03	24.5	4	35	3.5	16	5.1	55
GN.51419	GN 306-45-M6-20-ZK-SW	45	M6	10	13	4.5±0.03	24.5	4	35	3.5	20	5.1	56
GN.51429	GN 306-45-M6-25-ZK-SW	45	M6	10	13	4.5±0.03	24.5	4	35	3.5	25	5.1	58
GN.51439	GN 306-45-M6-32-ZK-SW	45	M6	10	13	4.5±0.03	24.5	4	35	3.5	32	5.1	59
GN.51449	GN 306-45-M6-40-ZK-SW	45	M6	10	13	4.5±0.03	24.5	4	35	3.5	40	5.1	60
GN.51459	GN 306-45-M6-50-ZK-SW	45	M6	10	13	4.5±0.03	24.5	4	35	3.5	50	5.1	62
GN.51609	GN 306-63-M8-20-ZK-SW	63	M8	13.5	17.5	6.1±0.05	31	6.5	45	4	20	6.2	78
GN.51619	GN 306-63-M8-25-ZK-SW	63	M8	13.5	17.5	6.1±0.05	31	6.5	45	4	25	6.2	80
GN.51629	GN 306-63-M8-32-ZK-SW	63	M8	13.5	17.5	6.1±0.05	31	6.5	45	4	32	6.2	82
GN.51639	GN 306-63-M8-40-ZK-SW	63	M8	13.5	17.5	6.1±0.05	31	6.5	45	4	40	6.2	84
GN.51649	GN 306-63-M8-50-ZK-SW	63	M8	13.5	17.5	6.1±0.05	31	6.5	45	4	50	6.2	85
GN.51659	GN 306-63-M8-63-ZK-SW	63	M8	13.5	17.5	6.1±0.05	31	6.5	45	4	63	6.2	87
GN.51669	GN 306-63-M10-20-ZK-SW	63	M10	13.5	17.5	7.8±0.05	31	6.5	45	4	20	7.3	81
GN.51679	GN 306-63-M10-25-ZK-SW	63	M10	13.5	17.5	7.8±0.05	31	6.5	45	4	25	7.3	84
GN.51689	GN 306-63-M10-32-ZK-SW	63	M10	13.5	17.5	7.8±0.05	31	6.5	45	4	32	7.3	86
GN.51699	GN 306-63-M10-40-ZK-SW	63	M10	13.5	17.5	7.8±0.05	31	6.5	45	4	40	7.3	91
GN.51709	GN 306-63-M10-50-ZK-SW	63	M10	13.5	17.5	7.8±0.05	31	6.5	45	4	50	7.3	96
GN.51719	GN 306-63-M10-63-ZK-SW	63	M10	13.5	17.5	7.8±0.05	31	6.5	45	4	63	7.3	100

Conversion Table	
1 mm = 0.039 inch	
l1	
mm	inch
30	1.18
45	1.77
63	2.48

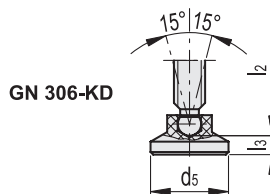

GN 306-KD

METRIC

Code	Description	l1	d1	d3	d4	d5	h1	h2	h3	h4	l2	l3	⚖
GN.51203	GN 306-30-M6-16-KD-SW	30	M6	10	13	15	24.5	4	31	3.5	16	3.6	25
GN.51213	GN 306-30-M6-20-KD-SW	30	M6	10	13	15	24.5	4	31	3.5	20	3.6	30
GN.51223	GN 306-30-M6-25-KD-SW	30	M6	10	13	15	24.5	4	31	3.5	25	3.6	31
GN.51233	GN 306-30-M6-32-KD-SW	30	M6	10	13	15	24.5	4	31	3.5	32	3.6	32
GN.51243	GN 306-30-M6-40-KD-SW	30	M6	10	13	15	24.5	4	31	3.5	40	3.6	33
GN.51253	GN 306-30-M6-50-KD-SW	30	M6	10	13	15	24.5	4	31	3.5	50	3.6	35
GN.51403	GN 306-45-M6-16-KD-SW	45	M6	10	13	15	24.5	4	35	3.5	16	3.6	57
GN.51413	GN 306-45-M6-20-KD-SW	45	M6	10	13	15	24.5	4	35	3.5	20	3.6	58
GN.51423	GN 306-45-M6-25-KD-SW	45	M6	10	13	15	24.5	4	35	3.5	25	3.6	59
GN.51433	GN 306-45-M6-32-KD-SW	45	M6	10	13	15	24.5	4	35	3.5	32	3.6	60
GN.51443	GN 306-45-M6-40-KD-SW	45	M6	10	13	15	24.5	4	35	3.5	40	3.6	61
GN.51453	GN 306-45-M6-50-KD-SW	45	M6	10	13	15	24.5	4	35	3.5	50	3.6	62
GN.51603	GN 306-63-M8-20-KD-SW	63	M8	13.5	17.5	18	31	6.5	45	4	20	4.2	85
GN.51613	GN 306-63-M8-25-KD-SW	63	M8	13.5	17.5	18	31	6.5	45	4	25	4.2	86
GN.51623	GN 306-63-M8-32-KD-SW	63	M8	13.5	17.5	18	31	6.5	45	4	32	4.2	89
GN.51633	GN 306-63-M8-40-KD-SW	63	M8	13.5	17.5	18	31	6.5	45	4	40	4.2	91
GN.51643	GN 306-63-M8-50-KD-SW	63	M8	13.5	17.5	18	31	6.5	45	4	50	4.2	93
GN.51653	GN 306-63-M8-63-KD-SW	63	M8	13.5	17.5	18	31	6.5	45	4	63	4.2	110
GN.51663	GN 306-63-M10-20-KD-SW	63	M10	13.5	17.5	21	31	6.5	45	4	20	4.3	84
GN.51673	GN 306-63-M10-25-KD-SW	63	M10	13.5	17.5	21	31	6.5	45	4	25	4.3	87
GN.51683	GN 306-63-M10-32-KD-SW	63	M10	13.5	17.5	21	31	6.5	45	4	32	4.3	90
GN.51693	GN 306-63-M10-40-KD-SW	63	M10	13.5	17.5	21	31	6.5	45	4	40	4.3	94
GN.51703	GN 306-63-M10-50-KD-SW	63	M10	13.5	17.5	21	31	6.5	45	4	50	4.3	100
GN.51713	GN 306-63-M10-63-KD-SW	63	M10	13.5	17.5	21	31	6.5	45	4	63	4.3	110

